

Feature

- Meets IEEE802.3&ANSI X 3.263 Standards
- RoHS Compliant
- 10/100 Base-T Through-Hole Type
- Operating Temperature Range: 0°C to +70°C



Electrical Specifications@25°C								
Part Number	OCL(uH Min) @100KHz/V with 8mA DC Bias	L.L (uH Max)	Cw/w (pF Max)	DCR (Ω Max)	HI-POT (Vrms)	T/R (±3%)		
						TX	RX	
FB20103N	350	0.5	56	1.2	1500	1CT:1CT	1CT:1CT	
Continue								
Part Number	Insertion Loss(dBMax)	Return Loss(dBMin)			Cross talk (dB Min)	DCMR (dBMin)		
		1-100MHz	0.5-30MHz	30-60MHz			60-100MHz	1-100MHz
FB20103N	-1.0	-18	-14	-12	-30	-30		

MECHANICAL

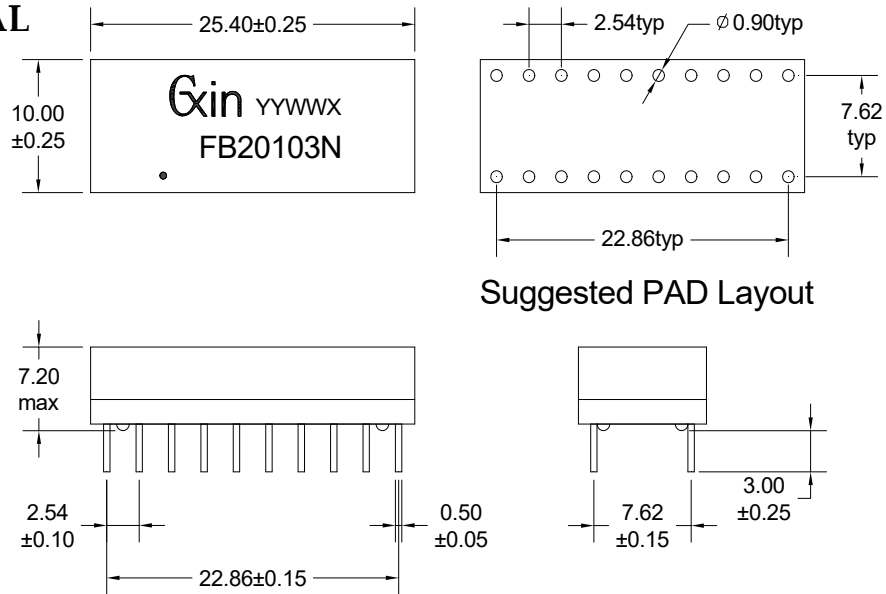

SCHEMATICS

